

Linear

TIMI Cove A040 (40W) Fixture Guide

KKDÖ

Indoor | Surface | Output up to 4800lm/m (1463lm/ft)



Key applications

- ✓ Architectural detail
- ✓ Interior
- ✓ Cove lighting
- ✓ Retail display
- ✓ Direct lighting
- ✓ Wall grazing
- ✓ Flood lighting
- ✓ Wall mounting
- ✓ Indirect lighting

Key features

- ✓ A-line (High Efficacy)
- ✓ Extensive CCT range
- ✓ Adjustable
- ✓ High lumen efficacy
- ✓ Custom lengths
- ✓ IP40 dry area
- ✓ Constant Voltage (CV)
- ✓ Lens options
- ✓ Diffusion: spotting

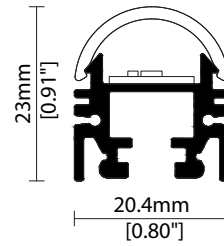

MOUNTING METHODS

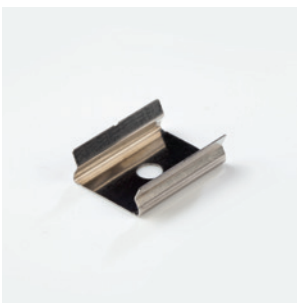

KKCP-11 Concealed clip



KKBK-25 Adjustable bracket

Linear

TIMI Cove A040 (40W)

Specification sheet



Dimensions	H23/W20.4/L90-1513mm (H0.91/W0.8/L3.54-59.56in) (excluding brackets)
PCB Cut-point	38.46mm increment/2000mm max (1.51in increment/78.74in max)
LED Pitch	4.8mm - 208LED/m (0.19in - 64LED/ft)
Chip	A-line
Cover/Optics	Clear (110°) / Diffused (130°) / Semi-diffused (115°) / KKLN-02 lens (30°)
CCT	A-line: 2700K/3000K/4000K
LED binning	A-line: 3-step MacAdam ellipse
CRI	≥94
Lifetime	50,000 hours @ 25°C (50,000 hours @ 77°F)
Operating temp	T _a = -25 to 40°C (T _c max = 83.2°C) T _a = -13 to 104°F (T _c max = 181°F)
IP Rating	IP40
Finish	Silver anodised
Mounting	Surface mounting via clips or brackets
Power feed	Hardwire tails or male/female connectors
Control	0-10V/1-10V/DMX/DALI



LED Grading Key

Exclusive Grade *KKDC tuned CCT range
A-line* 3-step CCT range
 KKDC highest lumen efficacy LED

Power consumption	Supply voltage	Supply current
40W/m (12.19W/ft)	24V DC	1.67A/m (0.51A/ft)

Performance Data (3000K)

	R1	R2	R3	R4	R5	R6	R7	R8	R9	R10	R11	R12	R13	R14
A-line	94	95	94	94	93	93	95	88	70	87	94	77	94	96

	Clear Cover	Diffused Cover	Semi-Diffused	30° Lens accessory (KKLN-02)	CRI	R9	Rf	Rg
A-line	4800lm/m (1463lm/ft) 120lm/W	3080lm/m (939lm/ft) 77lm/W	4600lm/m (1402lm/ft) 115lm/W	4560lm/m (1390lm/ft) 114lm/W	94	70	-	-

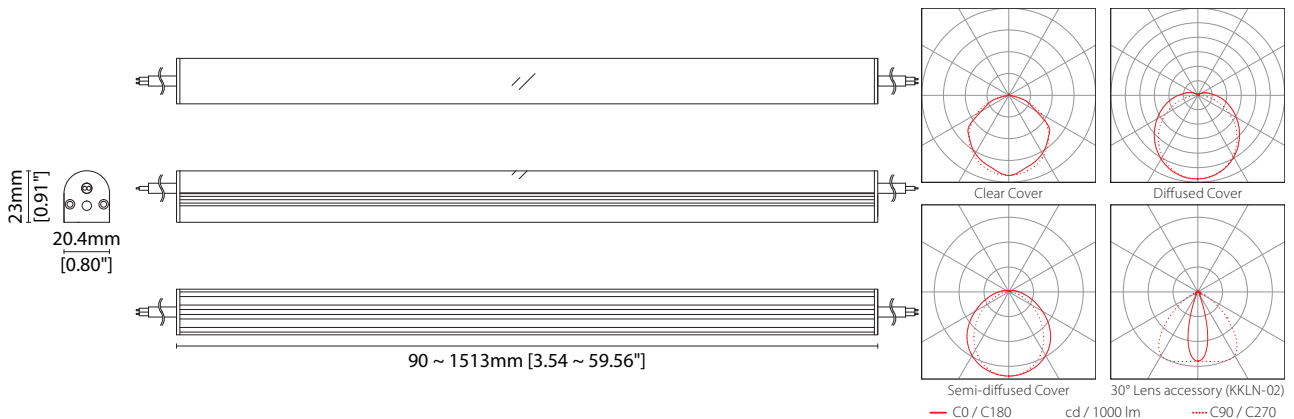

Data derived from independent UKAS / IESNA LM-79-08 accredited testing of production samples.

Linear

TIMI Cove A040 (40W)

Code Table



FIXTURE

Model	Finish	Cover/Lens ¹	Grade ²	LED	Colour (CCT)	Length Availability ³	IP	Cable Length	Power Feed ⁴	Input
TIMI Cove	PW Silver anodised	SA Clear	B	A040	2700K	m 90-1513mm 38.46mm increments	IP40	40 300mm/ 11.81"	S00A Single ø4.3mm sheath tail	DC 24V
			A		3000K					
			C		4000K	i 3.54-59.56in 1.51in increments				
			D		(Specify length code OR total run length)					
		H 30° KKLN-02						D00A Double ø4.3mm sheath tail		

¹ Refer to **Cover Options** on **Options** pages

² Refer to **LED Grading Key** on **Specification sheet** page

³ Refer to **Length Availability List** or enter total run length instead of length code

⁴ Refer to **Power Feed Options** on **Options** pages

Code Example:

PW	-	SA	-	C	-	A	-	040	-	30	-	m	-	513	-	40	-	0300	-	D00A	-	g
TIMI Cove		Silver anodised		Diffused		A		A040		3000K		513mm		IP40		300mm/11.81"		Double ø4.3mm sheath tail		DC 24V		

ACCESSORIES

Mounting Accessories

KKCP-11	Concealed Clip (allow 3 per metre/40in)
KKBK-25	Adjustable bracket (allow 2 per metre/40in)

* Refer to **Mounting accessories** on **Accessories** pages

Connection Accessories

KKCN-01	2 PIN male & female 50mm/1.97" pair
KKCN-03	2 PIN male & female 300mm/11.81" pair
KKCN-06	2 PIN 300mm/11.81" extension lead

* Refer to **Power feed** on **Accessories** pages

PSU/Driver

0-10V/1-10V/DALI/DMX

* Refer to **Driver/PSU Options** page for details or provide requirement and KKDC to offer the suitable option

LED ENGINE VARIANTS (LED STRIP TYPE)

Colour	LED	Lumen/m	Lumen/ft	W/m	W/ft	Spec Doc	Length	Increment
Single CCT	R030	2671	814	30	9.14	TIMI Cove R030	96-2013mm (3.78-79.25in)	41.7 (1.64in)
	A040	4800	1463	40	12.19	TIMI Cove A040	90-1513mm (3.54-59.56in)	38.46 (1.51in)

* Performance data: A/s/k-line, clear cover, 3000K

Linear

TIMI Cove A040 (40W)

Length Availability List



Length Code		Fixture Length ¹		LED Strip ²		End Cap Dimension ³		Wattage (W)	Output (lm)
Metric	Imperial(US)	Metric	Imperial(US)	Metric	Imperial(US)	Metric	Imperial(US)		3000K (Test Data)
m0090	i0004	90mm	3.54in	77mm	3.03in	3mm	0.12in	3.08	370
m0128	i0005	128mm	5.06in	115mm	4.55in	3mm	0.12in	4.62	554
m0167	i0007	167mm	6.57in	154mm	6.06in	3mm	0.12in	6.16	739
m0205	i0008	205mm	8.09in	192mm	7.57in	3mm	0.12in	7.70	923
m0244	i0010	244mm	9.60in	231mm	9.09in	3mm	0.12in	9.23	1108
m0282	i0011	282mm	11.11in	269mm	10.60in	3mm	0.12in	10.77	1293
m0321	i0013	321mm	12.63in	308mm	12.12in	3mm	0.12in	12.31	1477
m0359	i0014	359mm	14.14in	346mm	13.63in	3mm	0.12in	13.85	1662
m0398	i0016	398mm	15.66in	385mm	15.14in	3mm	0.12in	15.39	1846
m0436	i0017	436mm	17.17in	423mm	16.66in	3mm	0.12in	16.93	2031
m0475	i0019	475mm	18.69in	462mm	18.17in	3mm	0.12in	18.46	2216
m0513	i0020	513mm	20.20in	500mm	19.69in	3mm	0.12in	20.00	2400
m0552	i0022	552mm	21.71in	539mm	21.20in	3mm	0.12in	21.54	2585
m0590	i0023	590mm	23.23in	577mm	22.72in	3mm	0.12in	23.08	2770
m0628	i0025	628mm	24.74in	615mm	24.23in	3mm	0.12in	24.62	2954
m0667	i0026	667mm	26.26in	654mm	25.74in	3mm	0.12in	26.16	3139
m0705	i0028	705mm	27.77in	692mm	27.26in	3mm	0.12in	27.69	3323
m0744	i0029	744mm	29.28in	731mm	28.77in	3mm	0.12in	29.23	3508
m0782	i0031	782mm	30.80in	769mm	30.29in	3mm	0.12in	30.77	3693
m0821	i0032	821mm	32.31in	808mm	31.80in	3mm	0.12in	32.31	3877
m0859	i0034	859mm	33.83in	846mm	33.31in	3mm	0.12in	33.85	4062
m0898	i0035	898mm	35.34in	885mm	34.83in	3mm	0.12in	35.39	4246
m0936	i0037	936mm	36.86in	923mm	36.34in	3mm	0.12in	36.92	4431
m0975	i0038	975mm	38.37in	962mm	37.86in	3mm	0.12in	38.46	4616
m1013	i0040	1013mm	39.88in	1000mm	39.37in	3mm	0.12in	40.00	4800
m1052	i0041	1052mm	41.40in	1039mm	40.89in	3mm	0.12in	41.54	4985
m1090	i0043	1090mm	42.91in	1077mm	42.40in	3mm	0.12in	43.08	5169
m1128	i0044	1128mm	44.43in	1115mm	43.91in	3mm	0.12in	44.62	5354
m1167	i0046	1167mm	45.94in	1154mm	45.43in	3mm	0.12in	46.16	5539
m1205	i0047	1205mm	47.45in	1192mm	46.94in	3mm	0.12in	47.69	5723
m1244	i0049	1244mm	48.97in	1231mm	48.46in	3mm	0.12in	49.23	5908
m1282	i0050	1282mm	50.48in	1269mm	49.97in	3mm	0.12in	50.77	6092
m1321	i0052	1321mm	52.00in	1308mm	51.49in	3mm	0.12in	52.31	6277
m1359	i0054	1359mm	53.51in	1346mm	53.00in	3mm	0.12in	53.85	6462
m1398	i0055	1398mm	55.03in	1385mm	54.51in	3mm	0.12in	55.39	6646
m1436	i0057	1436mm	56.54in	1423mm	56.03in	3mm	0.12in	56.92	6831
m1475	i0058	1475mm	58.05in	1462mm	57.54in	3mm	0.12in	58.46	7015
m1513	i0060	1513mm	59.57in	1500mm	59.06in	3mm	0.12in	60.00	7200

¹ Actual total overall length of light fixture (LED strip + end caps + void/wire hole)

² Actual length of PCB strip

³ Actual length of 2x end caps

Linear

TIMI Cove A040 (40W)

Length Availability List

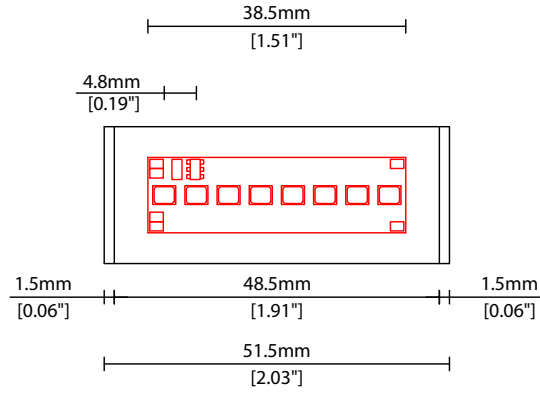

Linear

TIMI Cove A040 (40W) Options

KKDC

COVER OPTIONS

* Options are an integral part of the fixture ordering codes. Please refer to **Code Table** pages.



B Clear
W20.3/H23mm (W0.80/H0.91")

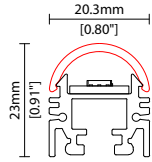

C Diffused
W20.3/H23mm (W0.80/H0.91")

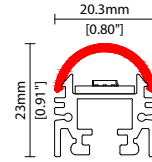

D Semi-diffused
W20.3/H23mm (W0.80/H0.91")

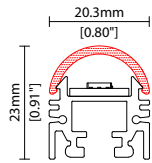

H 30° KKLN-02
W20.4/H23mm (W0.80/H0.91")

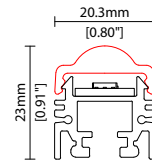

Linear

TIMI Cove A040 (40W)

Options

KKDC

POWER FEED OPTIONS

0300 S00A 300mm (11.81") Single \varnothing 4.3mm sheath tail

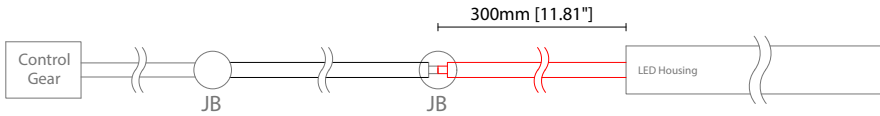

0300 D00A 300mm (11.81") Double \varnothing 4.3mm sheath tail

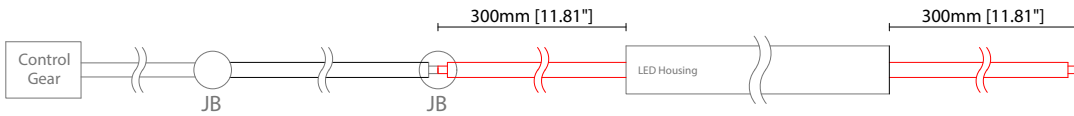

Key

Control Gear Power supply, sub-controllers & control systems
JB Junction box / cable connection

Linear

TIMI Cove A040 (40W) Accessories

KKDC

MOUNTING ACCESSORIES

Note: Accessories are to be ordered separately with corresponding code shown below.

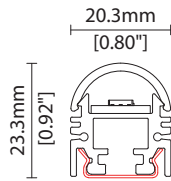
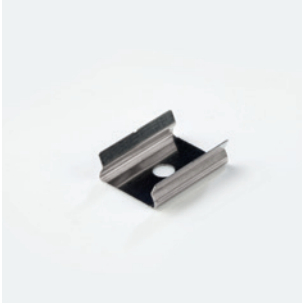

KKCP-11

Concealed clip
(allow 3 per metre/40in)
S/Steel finish
L20/W20.3/H23.3mm
(L0.79/W0.8/H0.92")

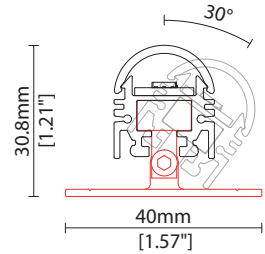

KKBK-25

Adjustable bracket
(allow 2 per metre/40in)
Anodised aluminium finish
L30/W40/H30.8mm
(L1.18/W1.57/H1.21")

POWER FEED

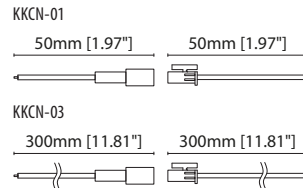
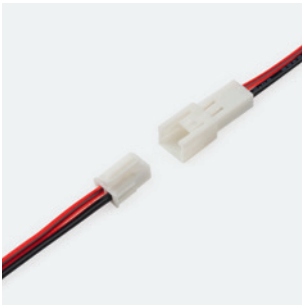

KKCN-01 50mm (1.97in) pair

KKCN-03 300mm (11.81in) pair

2 PIN male + female connector set



KKCN-06

2 PIN 300mm (11.81in) extension
lead

Linear

TIMI Cove A040 (40W)

Accessories

KKDC

KKDC CONTROL



IP20
Plastic housing
L170/W59/H29mm
(L6.69/W2.32/H1.14in)

KKDM-06 1-10V

visDIM dimmable sub-controller
(4 x 8A max @ 12-36V)



IP20
Plastic housing
L170/W53.4/H28mm
(L6.69/W2.10/H1.10in)

KKSC-05 DMX

visDIM dimmable sub-controller
(4 x 5A max @ 12-36V)



IP20
Plastic housing
L170/W59/H29mm
(L6.69/W2.32/H1.14in)

KKDL-02 DALI

visDIM dimmable sub-controller
(4 x 8A max @ 12-36V)



IP20
Plastic housing
L166/W53.4/H23mm
(L6.54/W2.10/H0.91in)

KKDL-03 DALI

visDIM dimmable sub-controller
(4 x 5A max @ 12-36V)

AVAILABLE PSU OPTIONS

Control Mode	PSU (Order Code)	Input Voltage AC	Output Voltage DC	Rated Output Current	Rated Power	Dim %	IP Rating
Switched	CEN-60-24	90-295V	24V	2.5A	60W	-	IP67
	HLG-60H-24	90-305V	24V	2.5A	60W	-	IP67
	HLG-100H-24	90-305V	24V	4.0A	100W	-	IP67
	HLG-150H-24	90-305V	24V	6.3A	150W	-	IP67
	HLG-240H-24	90-305V	24V	10A	240W	-	IP67
0-10V (1-10V)	PWM-40-24	90-305V	24V	1.67A	40W	100-0.15 (100-10)	IP67
	PWM-60-24	90-305V	24V	2.5A	60W	100-0.15 (100-10)	IP67
	PWM-90-24	90-305V	24V	3.67A	90W	100-0.15 (100-10)	IP67
	PWM-120-24	90-305V	24V	5.0A	120W	100-0.15 (100-10)	IP67
DALI	LIN100A1	120-277V	24V	1A per channel	100W	100-0.1	IP66/IP40
DMX RGB	LIN100A1	120-277V	24V	1.33A per channel	100W	100-0.1	IP66/IP40
DMX RGBW	LIN100A1	120-277A	24V	1A per channel	100W	100-0.1	IP66/IP40

Flicker Free Options - Combination of PSU+ sub-controller

Control Mode	PSU (Order Code)	Sub-controller (Order Code)	Input Voltage AC	Output Voltage DC	Rated Output Current	Rated Power	Dim %	IP Rating PSU/ Sub-controller
0-10V or 1-10V	CEN-60-24	KKDM-06	90-295V	24V	2.5A	60W	100-0.9	IP67/IP20
	HLG-60H-24	KKDM-06	90-295V	24V	2.5A	60W	100-0.9	IP67/IP20
	HLG-100H-24	KKDM-06	90-295V	24V	4.0A	100W	100-0.9	IP67/IP20
	HLG-150H-24	KKDM-06	90-295V	24V	6.3A	150W	100-0.9	IP67/IP20
	HLG-240H-24	KKDM-06	90-295V	24V	10.0A	240W	100-0.9	IP67/IP20
DALI	CEN-60-24	KKDL-02/03	90-295V	24V	2.5A	60W	100-0.1	IP67/IP20
	HLG-60H-24	KKDL-02/03	90-305V	24V	2.5A	60W	100-0.1	IP67/IP20
	HLG-100H-24	KKDL-02/03	90-305V	24V	4.0A	100W	100-0.1	IP67/IP20
	HLG-150H-24	KKDL-02/03	90-305V	24V	6.3A	150W	100-0.1	IP67/IP20
	HLG-240H-24	KKDL-02/03	90-305V	24V	10.0A	240W	100-0.1	IP67/IP20
DMX RGB	CEN-60-24	KKSC-05	90-295V	24V	2.5A	60W	100-0.9	IP67/IP20
	HLG-60H-24	KKSC-05	90-305V	24V	2.5A	60W	100-0.9	IP67/IP20
	HLG-100H-24	KKSC-05	90-305V	24V	4A	100W	100-0.9	IP67/IP20
	HLG-150H-24	KKSC-05	90-305V	24V	6.3A	150W	100-0.9	IP67/IP20
	HLG-240H-24	KKSC-05	90-305V	24V	10.0A	240W	100-0.9	IP67/IP20

¹ The items shown above cover the most frequently used specification but does not exhaust the possible options

² PSU and/or driver can be chosen from the table, or KKDC may recommend the best option upon receipt of the controls requirement and installation environment

³ Electrical shop drawing will include detailed information of PSU and relevant control drivers

⁴ Cut sheets are available on the controls section of www.kkdc.lighting or upon request